

How we spend fishing licence income

Fisheries Annual Report 2020-21



OUTCOMES

Here's how your licence fee directly supported angling and fisheries across England

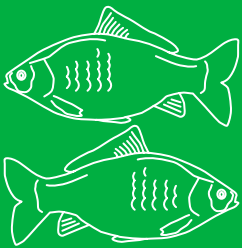

489,156

● Coarse fish supplied and stocked



119

● Stock surveys



1,200

● Project partners

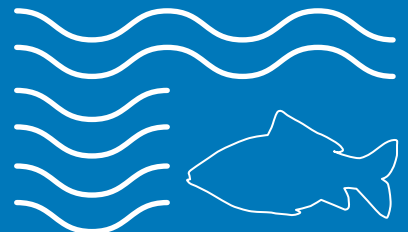

340

● Successful prosecutions

- Stocking fish
- Working with partners
- Protecting fisheries and preventing illegal fishing
- Prioritising a sustainable future for fisheries
- Improving fisheries habitat

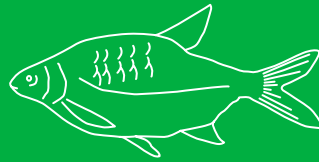

153ha

● Of stillwater fisheries enhanced



391

● Incidents at fisheries attended

575km

● Of river habitats opened up/improved

45

● Fish pass solutions completed

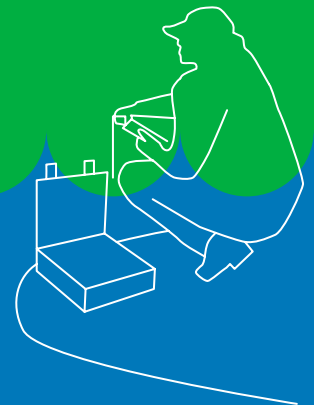

17,106

● Fishing licence checks

Nearly
£25,000,000

● Of fishing licence income was invested to deliver the fisheries service



Environment
Agency

WORK ACHIEVED

The full story of what we do with fishing licence income



Ever wondered how we use the money raised from fishing licence sales? We're proud of the fact that every penny from licence fees is reinvested back into the sport. Between April 2020 and March 2021 we sold over a million licences. Collectively, licence holders like you are helping us protect and improve everything you love about fishing - so thank you!

[Read our full report](#)

Your licence fee directly supports angling and fisheries across England, enabling us to:

- ✓ Improve fisheries habitat
- ✓ Improve fish stocks and fisheries
- ✓ Protect fisheries and reduce illegal fishing
- ✓ Secure a sustainable future for fisheries
- ✓ Work with partners to deliver more

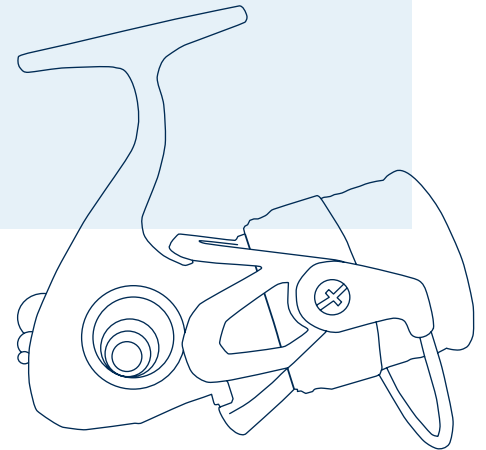

We reinvest 100% of fishing licence income to improve fisheries for people, the environment and angling.

PARTNERSHIPS

You'll see the impact of our partnership work almost every time you go fishing



The Wild Trout Trust undertook
75
advisory visits/practical demos and delivered
7
river habitat improvement projects

4,696
tried fishing for the first time thanks to the Angling Trust and its partners

The Riverfly Partnership undertook 3,778 invertebrate sample surveys worth
£892k

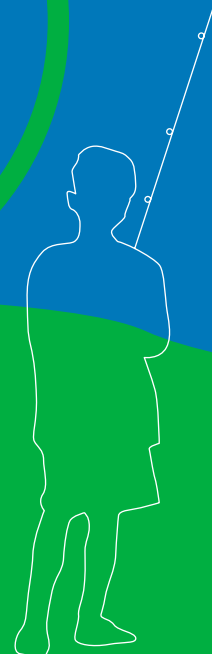
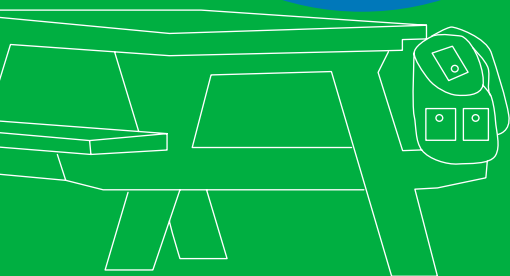
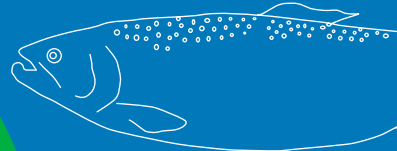

Partnerships are powerful! That's why in 2020-2021 we joined forces with over 1,200 like-minded groups and organisations. With fishing licence income, we were able to support and collaborate with partners such as local river trusts, angling clubs, charities and many more.

Through contributions we made to partners, fishing licence income helped:

- ✓ Launch the Get Fishing Fund, investing £200k to help angling clubs and fisheries restart participation events after lockdown.
- ✓ Nearly 4,000 invertebrate surveys take place and ensure a response to 197 trigger level alerts, indicating a possible pollution impact, giving greater understanding about the health of our rivers.
- ✓ Fund projects to the tune of £1.5m to improve fish stocks, and habitat.

[Read more about our partnership work](#)

PARTNERSHIPS



WILD TROUT TRUST



Institute of Fisheries Management



Canal & River Trust
Making life better by water



The Rivers Trust



GET HOOKED ON FISHING



IMPROVEMENT WORKS

Some of your licence income is invested into supporting projects that enhance habitat for fish. Improving habitat means better angling opportunities and resilient fisheries.



1



2



3

1. Creating 'off flow' refuge for fry offering protection during high flows
2. Stabilising banks helps prevent sediment release, protecting spawning habitat
3. Restoration works on a chalk stream in Cambridgeshire
4. Fish passes improve access for spawning, feeding and predator avoidance
– River Cam, Cambridgeshire

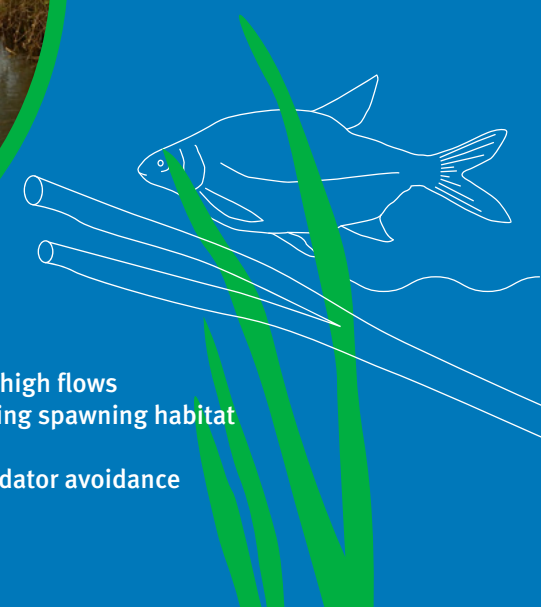
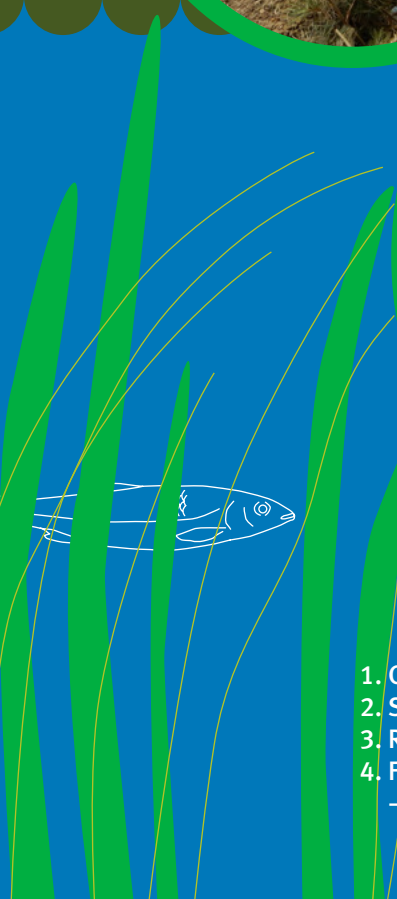

In 2020-2021 we directly funded over 200 projects on 575km of river and 153 hectares of still waters.

These projects included:

- ✓ 172 Fisheries Improvement projects
- ✓ 47 Angling Improvement Fund projects
- ✓ 45 fish passes constructed or barriers to fish removed

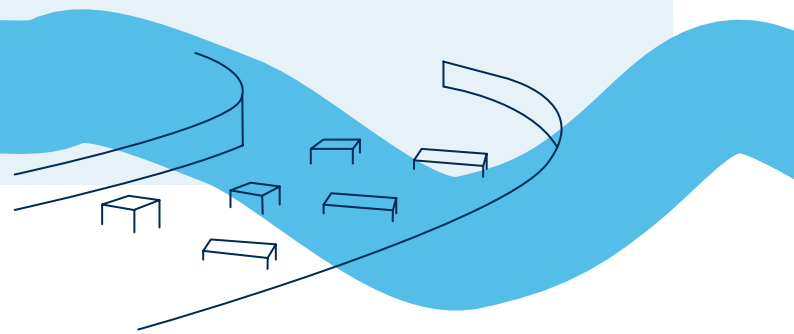

[Read more about our improvement projects](#)



Enhancing fisheries provides greater opportunities for spawning, feeding and avoiding predators or weather extremes like flood and drought. It doesn't just make ecological sense, it makes good fishing sense!

COARSE FISH STOCKING

Thanks for helping
stock nearly 500,000
fish back into our rivers
and stillwaters

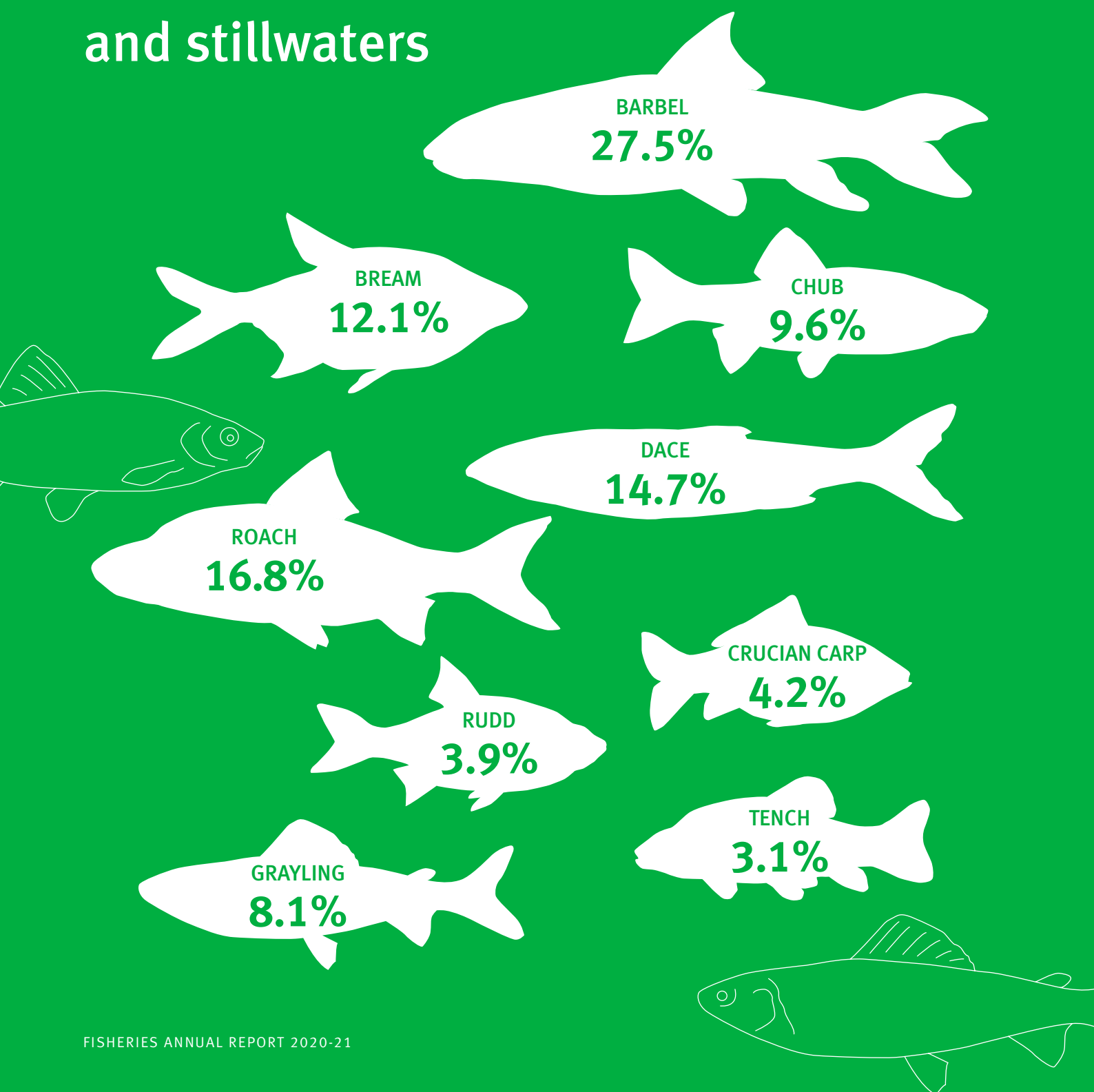

Rearing and releasing fish doesn't just ensure your angling experience is enjoyable, it also helps replenish stocks following an environmental incident, or kickstart recovery from longer term issues like pollution.

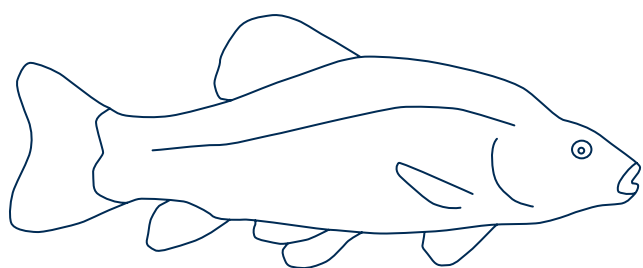

Read more about our coarse fish hatchery



In 2020-2021 we stocked 489,165 fish into rivers and stillwaters across the country for the benefit of anglers.

1. Part of a post pollution stocking – stocked fish are vital for the recovery of some fisheries
2. Barbel fry in our hatchery at Calverton fish farm
3. Calverton Fish Farm

NATIONAL FISHERIES LAB

Fishing licence income funds a world-class fisheries laboratory

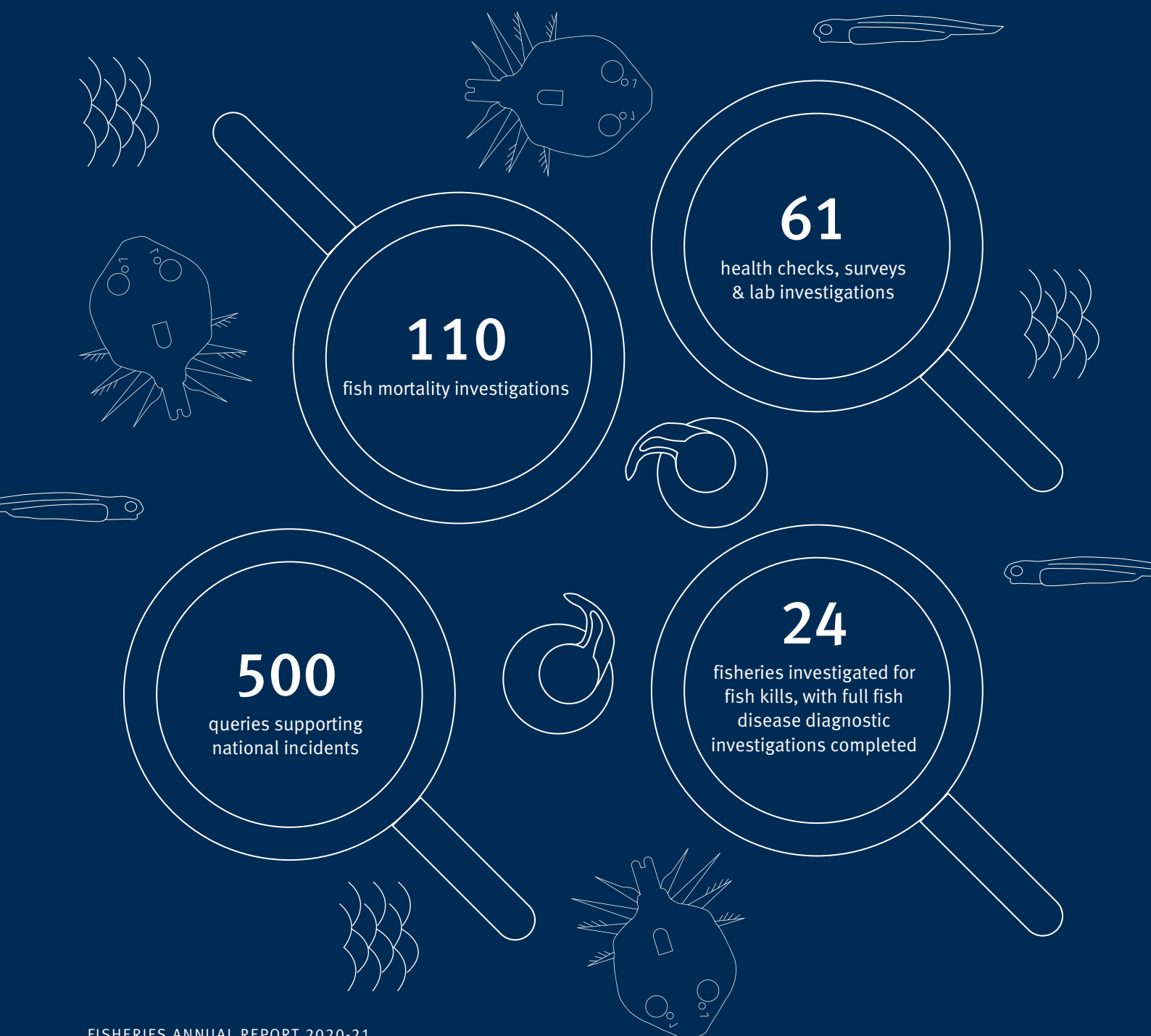

With your licence fee, we are able to ensure that fish are healthier and better protected, both today and in the future.

Our diagnostic investigations helped to:

- ✓ Detect the novel parasite, *Argulus mongolianus*
- ✓ Co-ordinate national reports of Red Skin Disease in wild Atlantic salmon
- ✓ Advised on the regulatory control of Carp Edema Virus (CEV) in carp fisheries

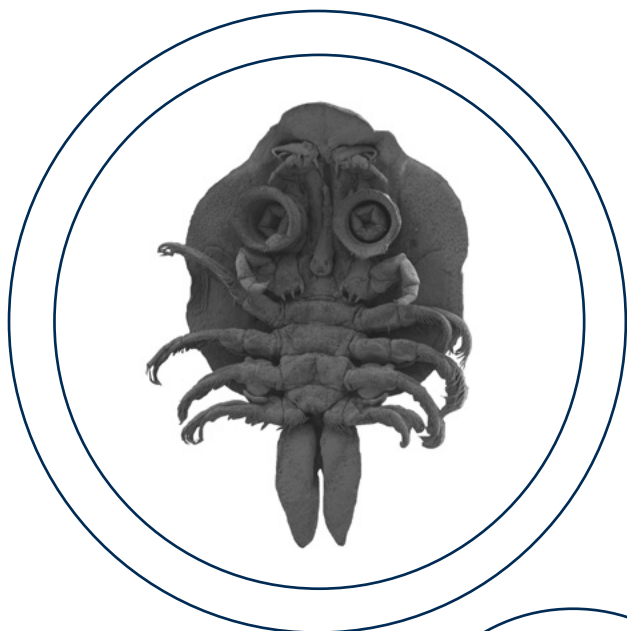

Read more about the work of our
National Fisheries Laboratory

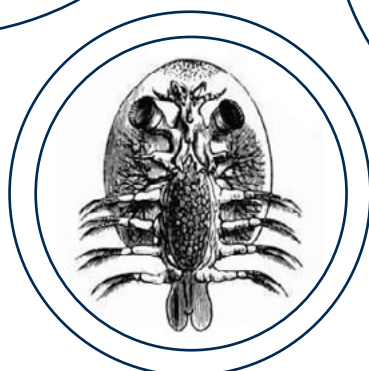

ENFORCEMENT

Your support helps us pursue unlicensed fishing and angling offences



17,106
licence checks



11,604
voluntary bailiff
patrols

Unlicensed anglers face a fine of up to **£2500**

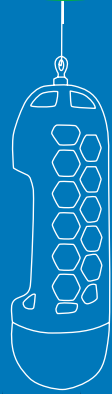

Always hold a valid fishing licence

Play your part!
Report offences to
0800 80 70 60

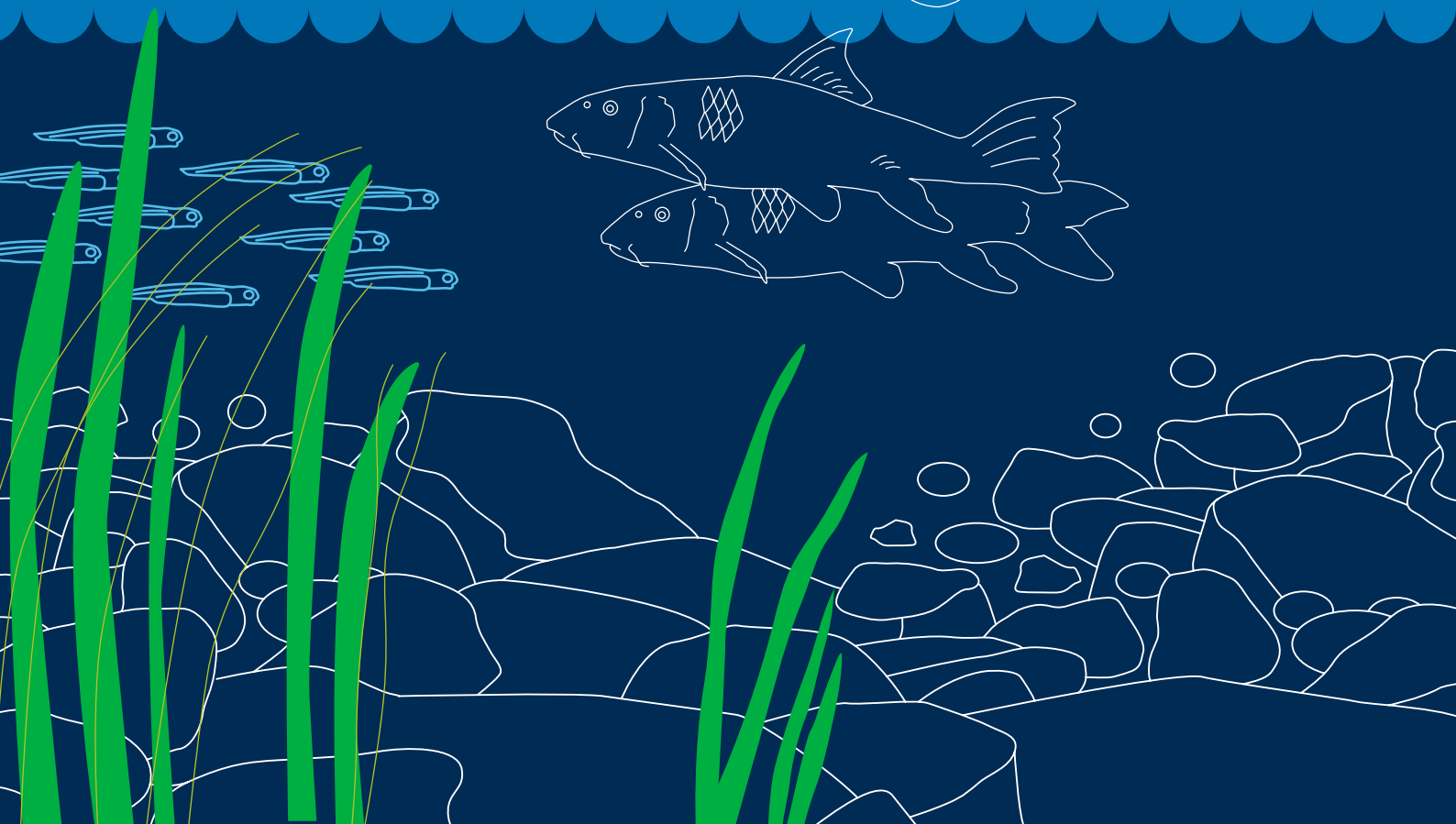

We work with the Angling Trusts Voluntary Bailiff Scheme (with 500 volunteers), police forces and other enforcement agencies to protect fisheries and prevent illegal fishing. Between 2020-2021 we checked 17,106 fishing licences and volunteer bailiffs carried out 11,604 patrols on our fisheries, resulting in more than 500 reports of incidents to ourselves or the police. Licence checks were significantly lower due to Covid – in 2019-2020 we checked over 61,000.

[Buy a rod fishing licence](#)

Below: A Fisheries Enforcement Officer checking a licence in East Anglia



INCIDENT RESPONSE

When an incident occurs, thanks to your fishing licence, we can be there

391
incidents
attended

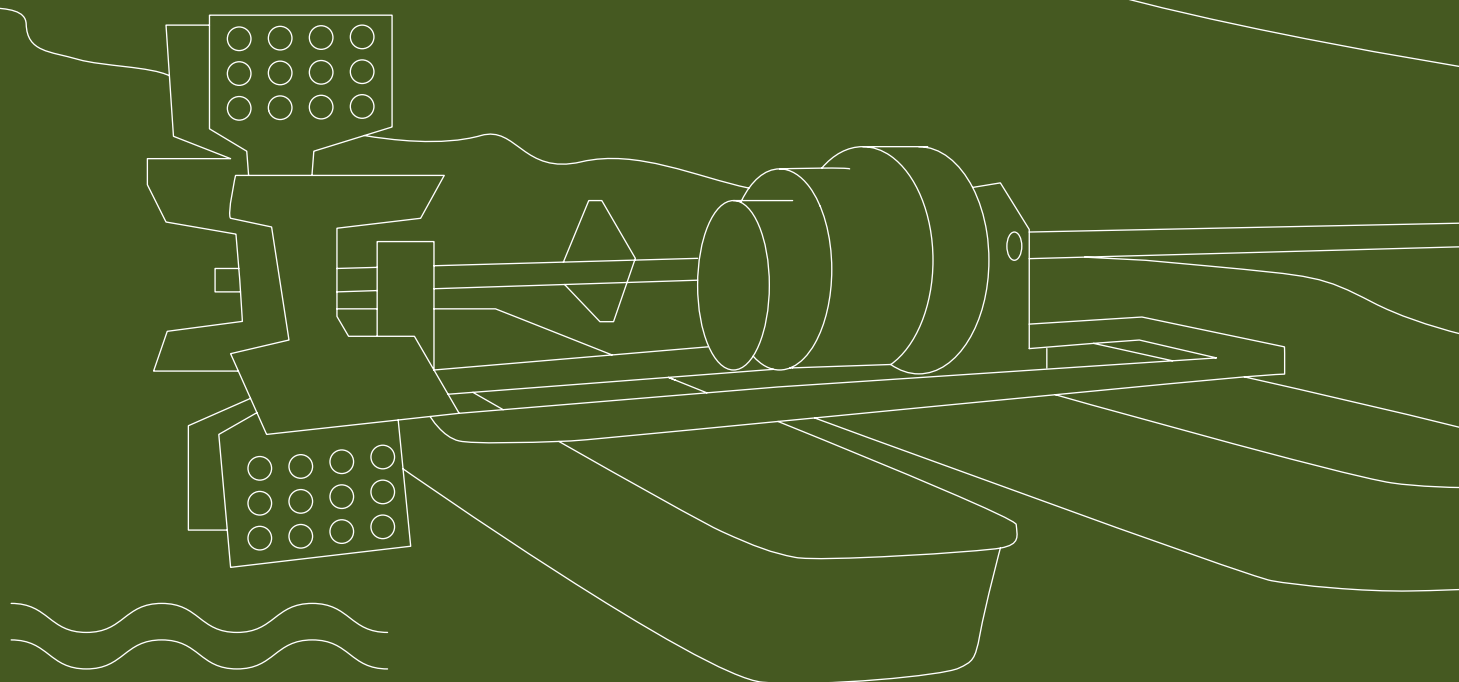
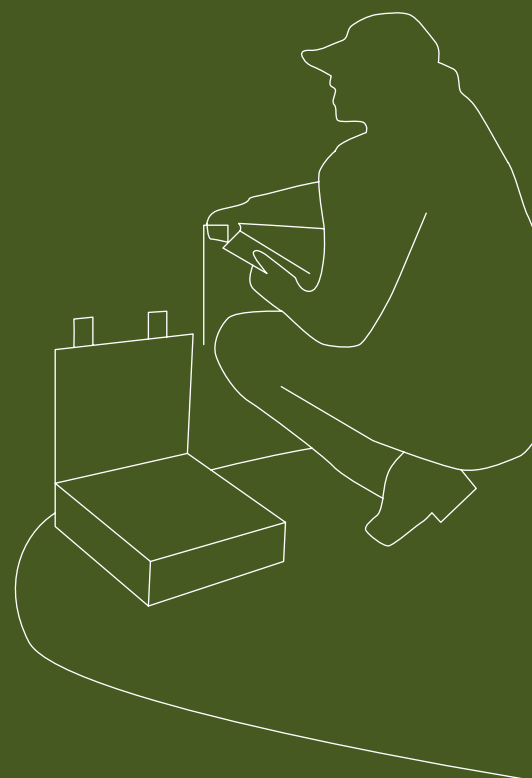

If you've ever come across dead or dying fish, you know just how concerning this can be, whether the cause is due to pollution, disease or an environmental incident. Thanks to your licence fee, between 2020 and 2021 we were able to respond to nearly 400 incidences like this.

Read more about the types
of incidents we attend

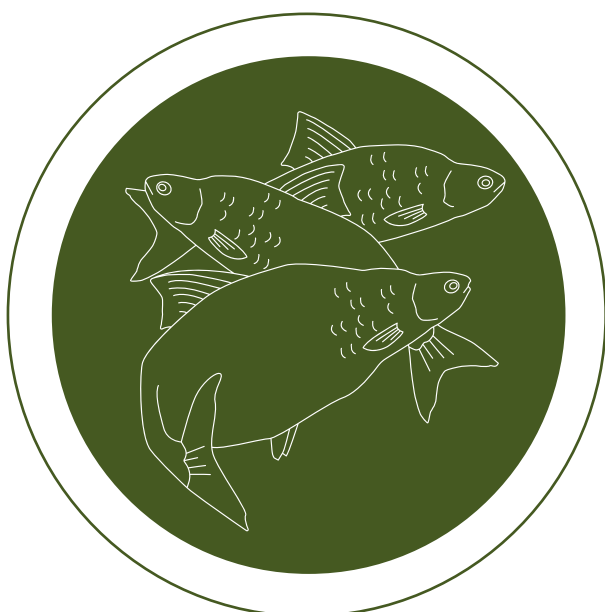

Witnessed a fish in
distress, dead or dying?
We can help.
Call our hotline on
0800 80 70 60.

MONITORING

Knowledge is power
- that's why we fund
monitoring with some of
our licence fee income



119
fish stock
surveys



Above: Monitoring fish populations using electric fishing on a recently constructed bypass channel

We carry out extensive, regular fish stock surveys and water quality monitoring on the rivers and stillwaters of greatest fishing interest or most at risk. Due to Covid, we carried out fewer surveys than the previous year - 119 compared to 1,521 in 2019-2021.

However, thanks to your fishing licence, monitoring helps to provide a wider indicator of the local environment. It's another way that your fishing licence directly supports fisheries both today and in the future.

[Read more about our
our fish stock surveys](#)

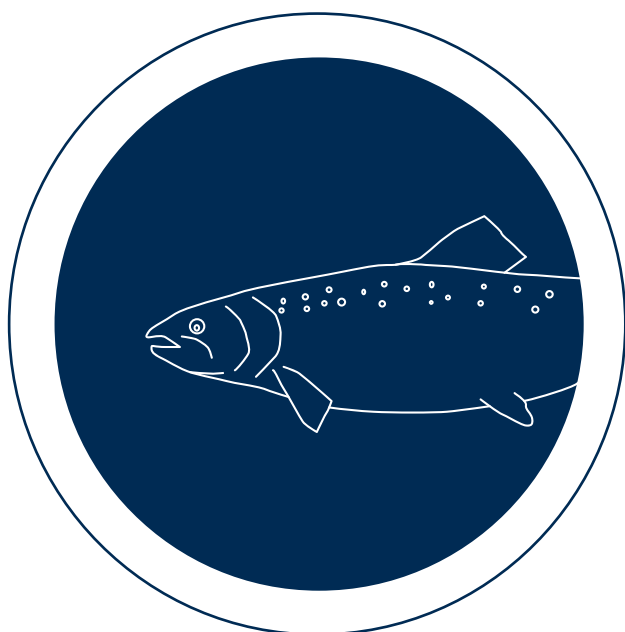

When we understand fish populations, where they are migrating, breeding, thriving or struggling, we can make informed decisions about how to manage fisheries and target improvements.

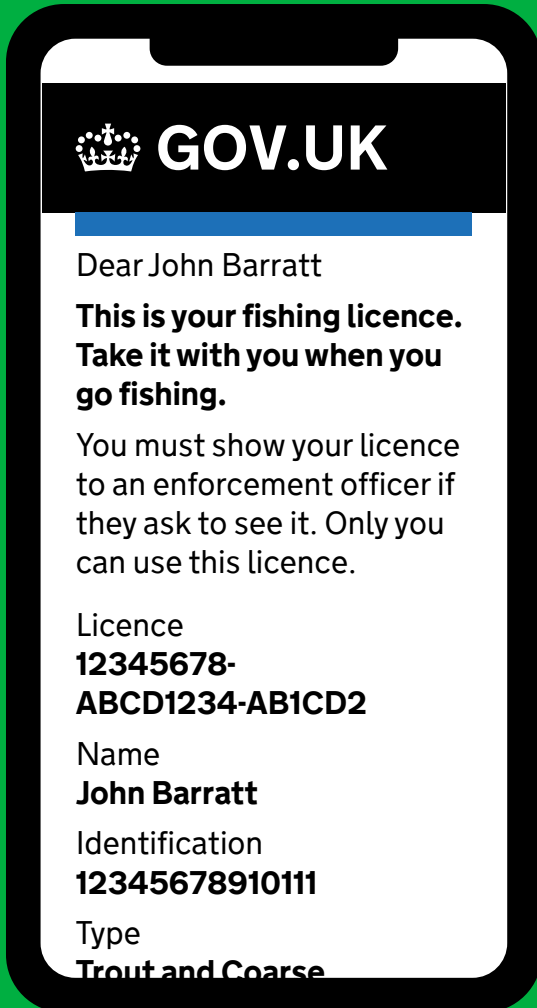

You're more than just a licence holder - you're integral to angling

The commitment you made in holding a fishing licence from 2020 to 2021 helped us deliver a vast range of great work in a challenging year. We couldn't have done it without you. Whether you're new to the sport or a life-long angler, we want to say thank you.

Paperless licence

Don't forget, you can now receive your licence by text or email. Moving to paperless licences will save us nearly £700k in costs and 49 tonnes of carbon!

£700k
costs saved

49t
of carbon
saved

“It's fantastic to see that over a million people went fishing last year and are recognising the benefits of this sport. The Environment Agency uses licence income to maintain, improve and develop fisheries across the country.

Whether it's preventing illegal fishing and poaching, responding to incidents or safeguarding habitats – all licence income is invested directly back into our fisheries and angling services.

When you buy a licence you help us continue this vital work and create new opportunities for anglers.”

Heidi Stone, Fisheries Partnership Manager, Environment Agency